

ER-BAJ is Side Cargo Door Operation

Main Deck: 30 Pallets Distribution

03 -Q6 Pallets (Position A1,A2 & B1) Max Weight 2611 Kg
 06-Q6 Pallets Max Height 96"
 20-Q7 Pallet Max Height 118"
 01-Q7 Pallet Max Height 113" Position PL

Pallet Max weight in position T is 2040 Kg

Lower Deck: 09 Pallets Distribution

09 Pallets Max Height 64"

- 1 - T- Q7 (include T, Max Gross weight 2040 for T only)
- 20 - Q7 (4819 Gross Weight)
- 8 - Q6 (2x 2611 MAX Gross Weight for A2 & B1 + 6 x 4819 MAX Gross Weight)
- 1 - A1 (2611 Gross MAX Weight + Height restriction mentioned in Attachment)
- 9 - W2 (5035 MAX Gross Weight) PLD/PWG
- 02 - PYB (1814 MAX Gross weight & Max height 90")

NOTE: - AKE & BULK NOT ALLOWED IN OUR AIRCRAFT
TOTAL: - 39 PMCs + 02 PYB CAN BE LOADED

Payload: For actual payload please contact Flight Operations Control 24*7 at +971 52 104 2246,
 Email:-occ@atc-md.aero

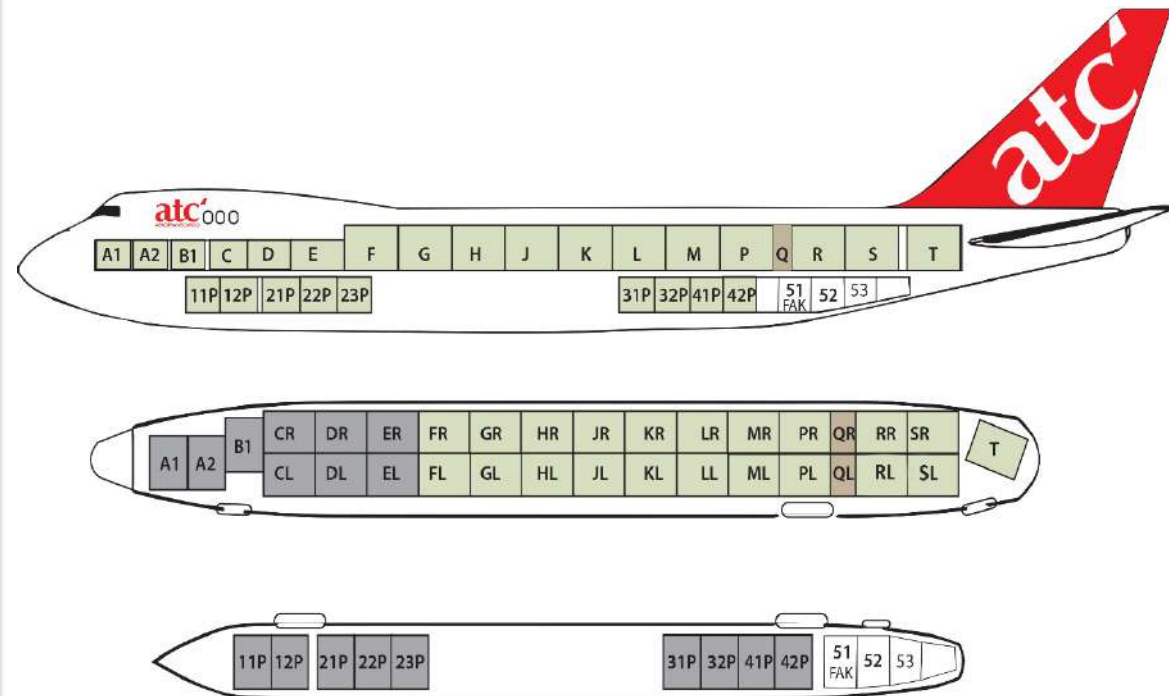

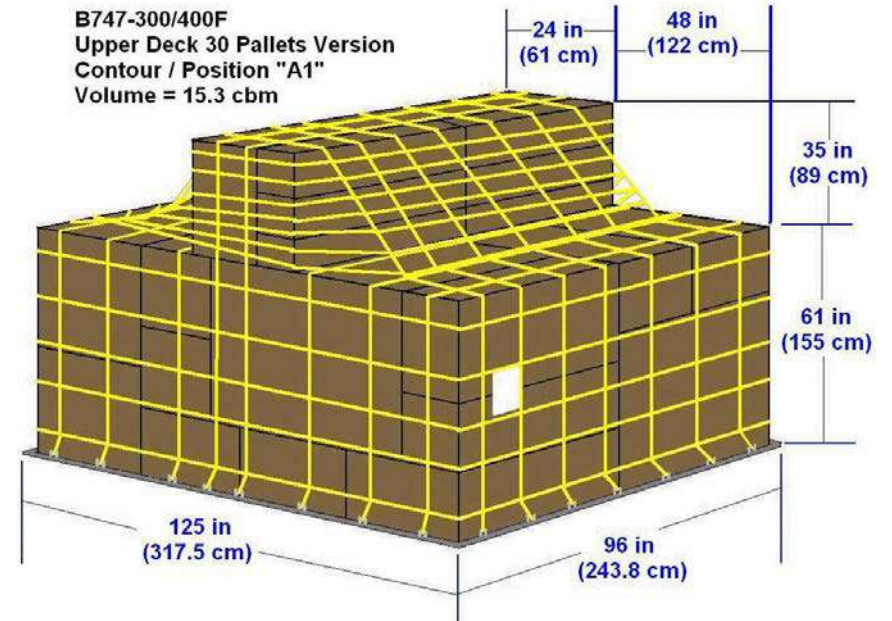
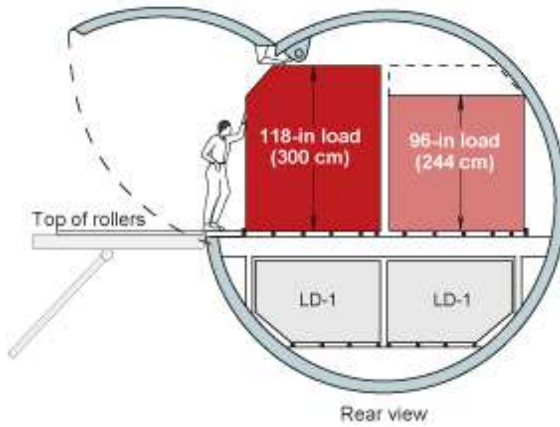
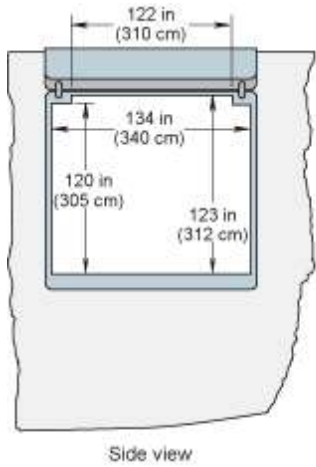

Car Loading Drive IN/OUT method

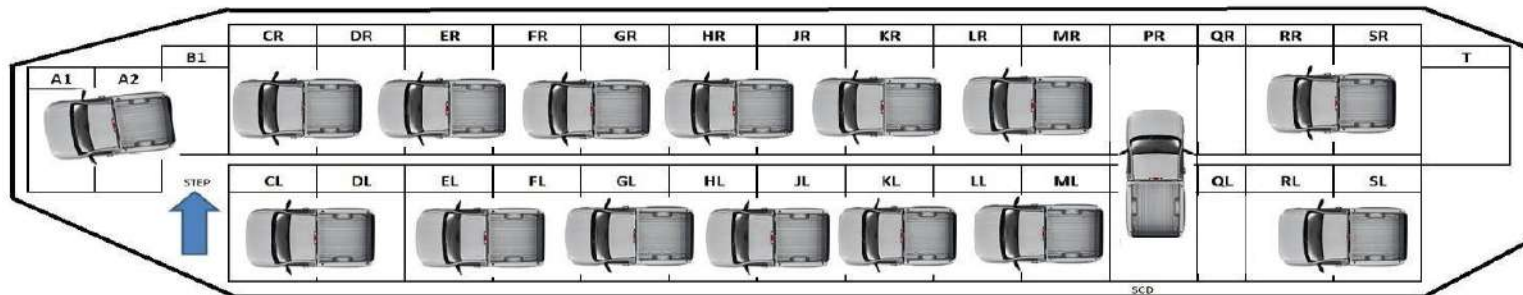

- The aircraft can be specially equipped to receive a full load of bulk-loaded animals. The animals are placed in a cage mounted on a regular aircraft pallet; the cage must be absolutely leak proof. Strong 2 layer of polyethylene sheeting must be placed between the container and the aircraft pallet and stapled to the sides of the container/Pallet. The plastic sheet should be raised to 01 meter in height around the cages to prevent animal waste leaking from the cage to aircraft floor. Absorbent material must be supplied in ample quantity. The use of straw must be avoided due to quarantine restrictions. Sufficient ventilation must be provided.
- Use total six lashing belts on each pallet, if pallet nets are not used for securing cages. If pallets nets are used to secure cages, please use 2 lashing belts on each side, so total 4 lashing belts per pallet.
- The container must be adequately ventilated on three sides, with the majority of the ventilation being provided on the upper part of the container.



Perishable Cargo (PER / PES / PEM / PEF)

- AEROTRASCARGO can maintain aircraft temperature from +4°C to +29°C in all compartments except in BULK.
- For packaging, use IATA Standard Packaging as per IATA PERISHABLE CARGO REGULATIONS.
- Stacking of shipment may crush lower/bottom packages due to weight load limitation. It is important to identify the load bearing tolerance for each box/piece within a shipment to prevent damages, where restriction exists; appropriate marking (DO NOT STACK & THIS WAY UP) should be used.
- Due to flat nature of a pallet, any liquid spill from a load may quickly spread to the aircraft structure and cause significant damage to Aircraft system. Depending on the nature of the perishable, the possibility of SPILLS must be evacuated. Most Seafood, FISH, FRESH MEAT or Liquid is considered as WET CARGO. These require absorbent pads to collect liquids that may escape from the products or coolants.
- Additional protection against leakage and spillage can be achieved by placing a plastic/polythene sheet on the ULD floor and turning the edges up against ULD wall to create a water resistant base around the shipment.



A ULD (Unit Load Device) is a device used to move cargo being shipped as airfreight. More specifically, a ULD is used to consolidate cargo in order to assist with the loading process onto an airplane.

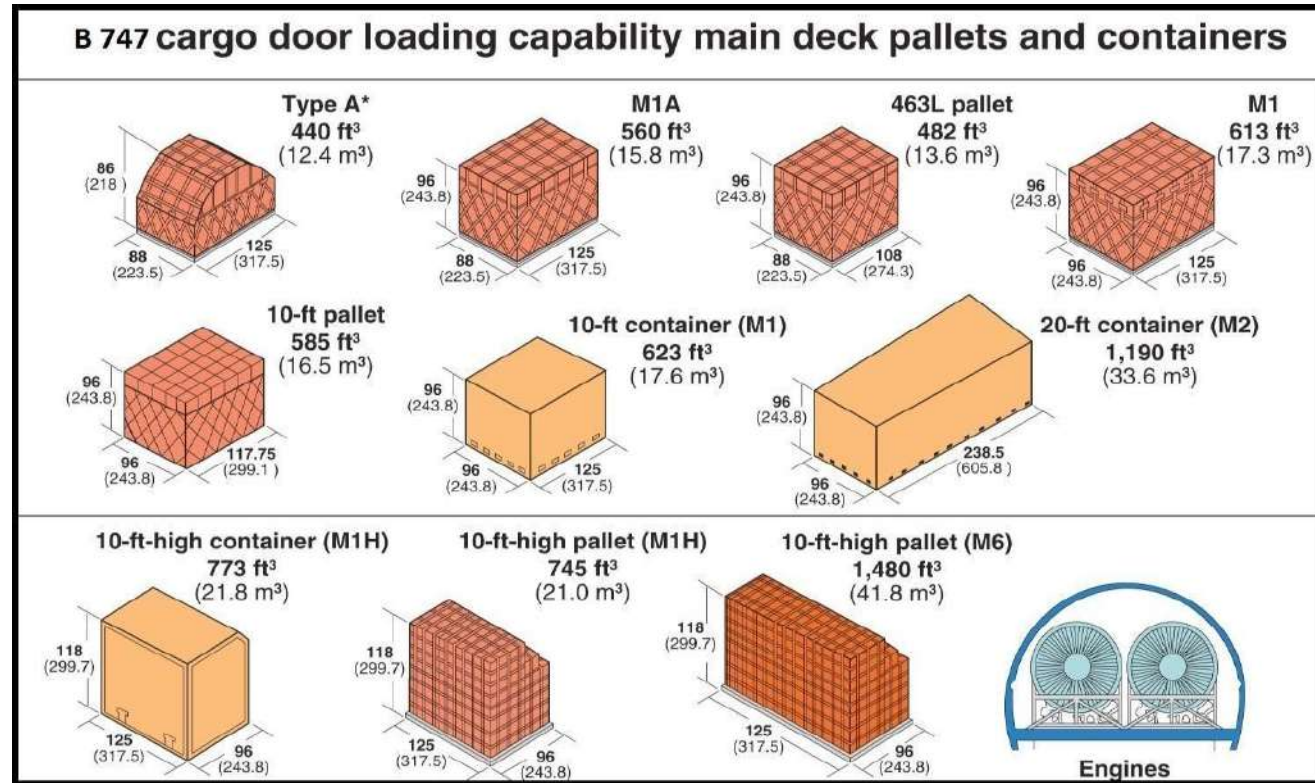
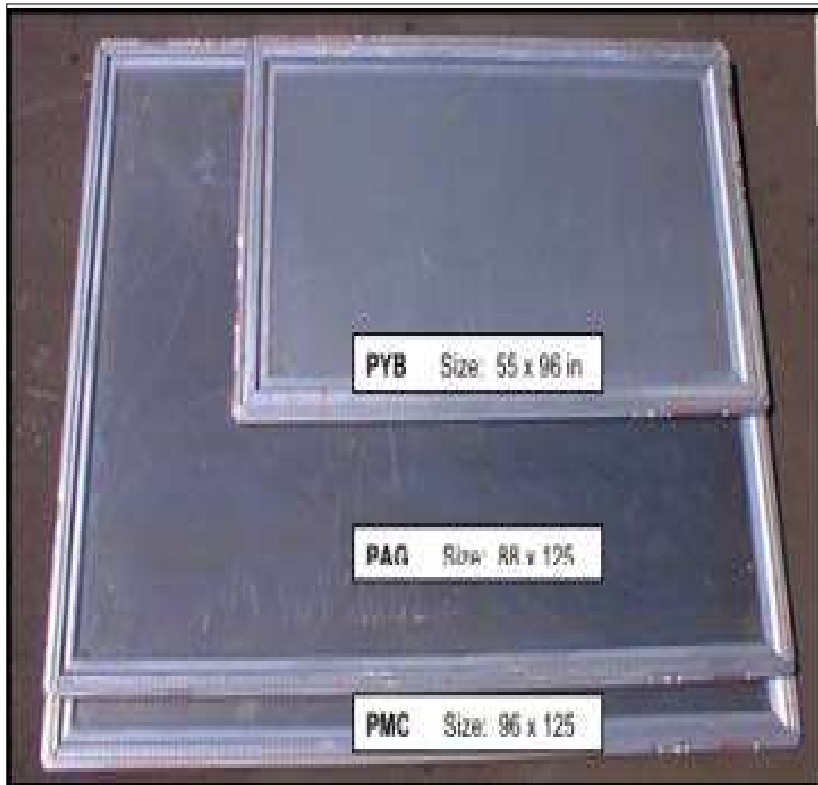

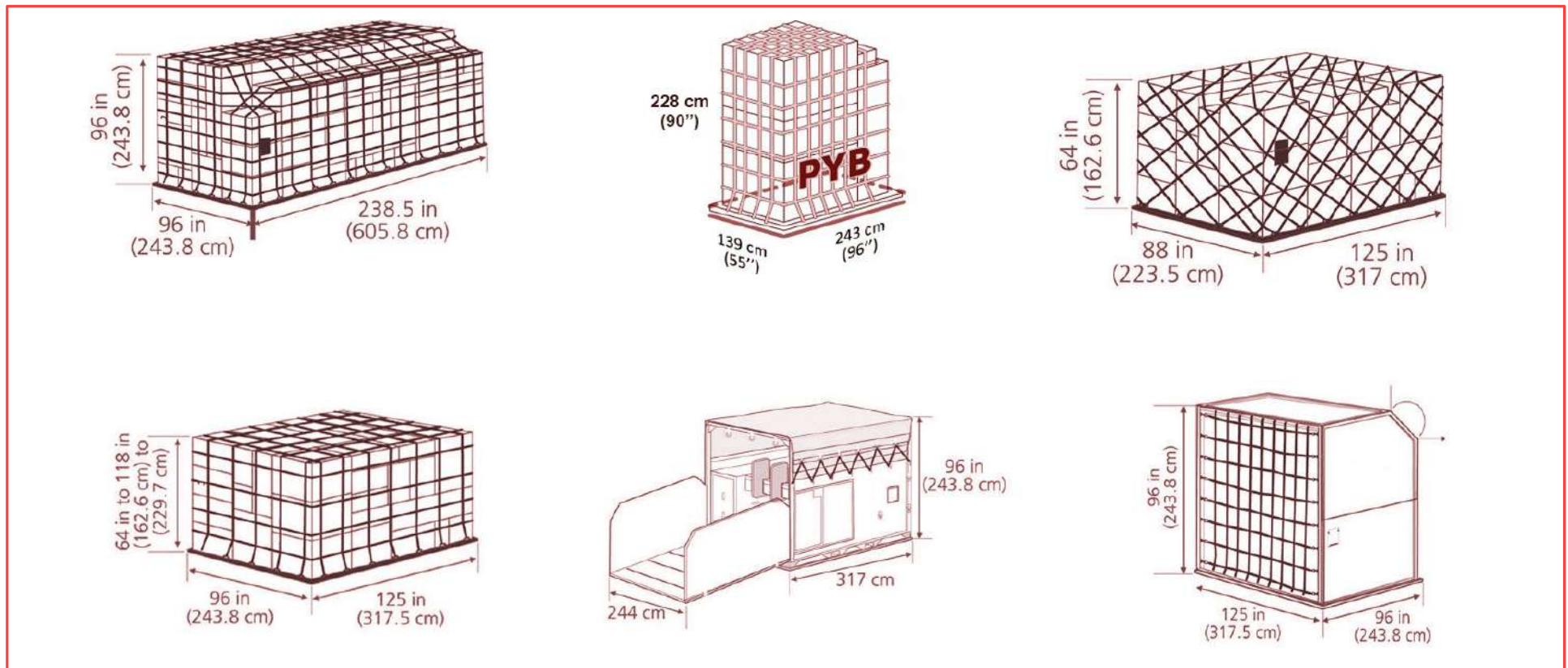

- Please refer latest IATA manual for Dangerous cargo, Live Stock, Perishables and Special Loads accepting /loading in ATC flights.
- Kindly use IATA Standard ULD's, Lashing Net & Belts and do not use any damage Nets/ Straps in ATC aircrafts.
- 20ft SEA/AIR containers not allowed to board on ATC Flights.
- 16ft/20ft pallets Max Weight allow 10,000Kg (Including ULD weight)